

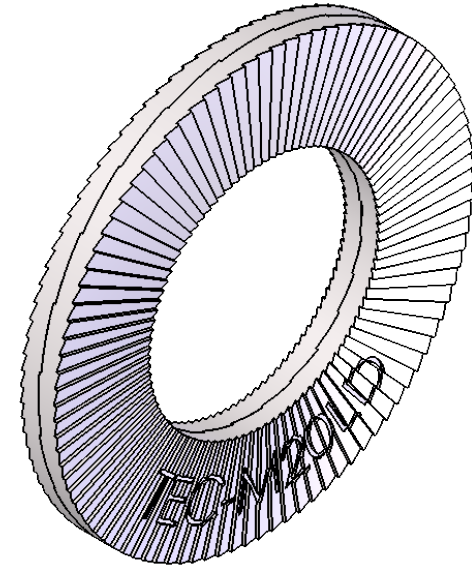

REVISIONS			
REV.	DESCRIPTION	DATE	ECN
A	INITIAL RELEASE	10/4/17	2813
B	MATERIAL UPDATE	7/12/2018	3056

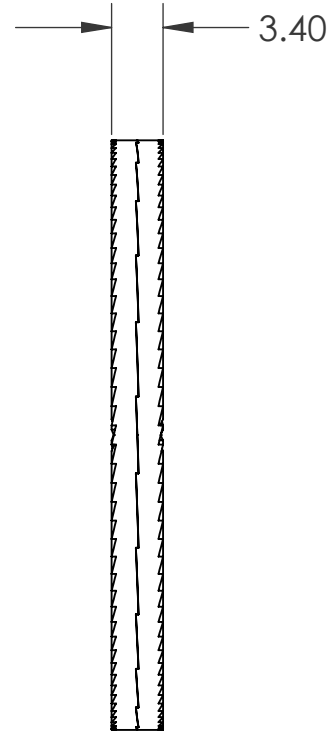
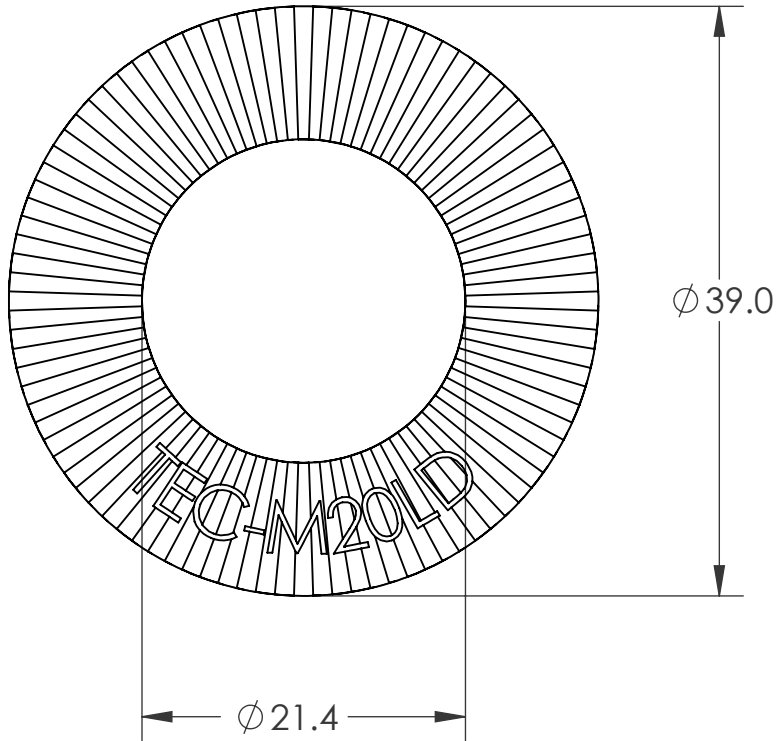

PROPRIETARY AND CONFIDENTIAL
 THIS DRAWING, AND THE INFORMATION CONTAINED
 HEREIN, ARE THE PROPERTY OF SHEREX AND ARE NOT
 TO BE USED IN ANY MANNER DETRIMENT TO THE
 INTEREST OF THE COMPANY.
 SHEREX FASTENING SOLUTIONS RESERVES THE RIGHT
 TO REVISE PART/DRAWING WITHOUT NOTICE.

DRAWING NO.:
TEC-M20LD

UNLESS OTHERWISE SPECIFIED:		NAME	DATE	
DIMENSIONS ARE IN MILLIMETERS TOLERANCES: ANGULAR: MACH ±1 BEND ±1 I.D. TOLERANCE: ±0.2 O.D. TOLERANCE: ±0.2 THICKNESS TOLERANCE: ±0.25		DRAWN	MTB	
INTERPRET GEOMETRIC TOLERANCING PER: ASME Y14.5M-1994		CHECKED		
MATERIAL		ENG APPR.	JVK	10/4/17
SCM435 OR 4130 STEEL, HT: THROUGH HARDEN 465 HV MIN		MFG APPR.		
FINISH		Q.A.		
DELTA PROTEKT BASE COAT (KL100) & TOP COAT (VH302GZ)		COMMENTS:		DESCRIPTION: LARGE DIAMETER TEC WASHER GLUED PAIR 20MM
DO NOT SCALE DRAWING		E-mail: info@disc-lock.com www.disc-lock.com Phone: 866-474-3739 Fax: 716-875-0358		
		SIZE PART NO.:		REV
		A TEC-M20LD		B
		SCALE: 2:1 WEIGHT:		SHEET 1 OF 1